

West P8100 1/8 Din Process Controller



With its improved interface, technical functionality and field flexibility, the West 8100 gives you the best in comprehensive control for most temperature and process control loops.

- Jumperless Configuration
- Auto Detected Hardware
- Process & Loop Alarms
- Modbus & ASCII Comms
- Auto or Manual Tuning
- Heat/Cool Operation
- Ramping Setpoint
- Remote/Dual Setpoint Options



Technical Data

Features

Control Types	Full PID with Pre-tune, Self-tune, manual tuning, or On-Off control. Heat only or heat & cool
Auto/Manual	Selectable from front panel or via digital input, with bumpless transfer
Output Configuration	Up to 3 possible, for control, alarm, 24VDC transmitter power supply or retransmit of process value or setpoint
Alarm 1 & 2 Types	Process high, process low, SP deviation, band, logical OR / AND. Also 1 loop alarm for process control security. Process alarms have adjustable hysteresis.
Human Interface	4 button operation, dual 4 digit 10mm & 8mm high LED displays, optional choice of colours (Red/Red, Red/Green, Green/Red or Green/Green), plus 5 LED indicators
PC Configuration	Off-line configuration from PC serial port to dedicated config socket (comms option not required). Configuration Software for Windows 98 or higher. West Part Number: PS1-CON

Input

Thermocouple	J, K, C, R, S, T, B, L, N & PtRh20%vsPtRh40%.
RTD	3 Wire PT100, 50Ω per lead maximum (balanced)
DC Linear	0 to 20mA, 4 to 20mA, 0 to 50mV, 10 to 50mV, 0 to 5V, 1 to 5V, 0 to 10V, 2 to 10V. Scaleable -1999 to 9999, with adjustable decimal point
Impedance	>10MΩ for Thermocouple and mV ranges, 47KΩ for V ranges and 5Ω for mA ranges
Accuracy	±0.1% of input range ±1 LSD (T/C CJC better than 1°C)
Sampling	4 per second, 14 bit resolution approximately
Sensor Break Detection	<2 seconds (except zero based DC ranges), control O/P's turn off, high alarms activate for T/C and mV ranges, low alarms activate for RTD, mA or V ranges

Outputs & Options

Control & Alarm Relays	Contacts SPDT 2 Amp resistive at 240V AC, >500,000 operations
Control SSR Driver Outputs	Drive capability >10V DC in 500Ω minimum
Triac Outputs	0.01 to 1 Amp AC, 20 to 280Vrms, 47 to 63Hz
DC Linear Outputs	0 to 20mA, 4 to 20mA into 500Ω max, 0 to 10V, 2 to 10V, 0 to 5V into 500Ω min. Control outputs have 2% over/under drive applied. Accuracy ±0.25% at 250Ω (degrades linearly to 0.5% for increasing burden to specified limits)
Transmitter Power Supply	Output 24VDC (nominal) into 910Ω minimum to power external devices
Serial Communications	2 Wire RS485, 1200 to 19200 Baud, Modbus and ASCII protocol (selectable)
Digital Input	Selects between 2 setpoints or Auto/Manual control. Volt free or TTL input
Remote Setpoint Input	0 to 20mA, 4 to 20mA, 0 to 100mV, 0 to 5V, 1 to 5V, 0 to 10V, 2 to 10V or ≥2KΩ Potentiometer Scaleable -1999 to 9999. Local/Remote setpoint selected from digital input (supplied as part of Full RSP) or front panel

Operating & Environmental

Temperature & RH	0 to 55°C (-20 to 80°C storage), 20% to 95% RH non-condensing
Power Supply	100 to 240V 50/60Hz 7.5VA (optional 20 to 48V AC 7.5VA/22 to 65V DC 5 watts)
Front Panel Protection	IEC IP66 (Behind panel protection is IP20)
Standards	CE, UL & ULC recognised

Dimensions

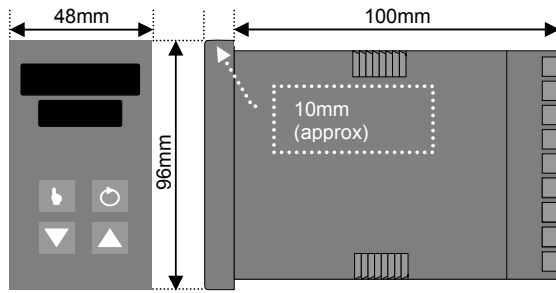

Cut out



Connection Details

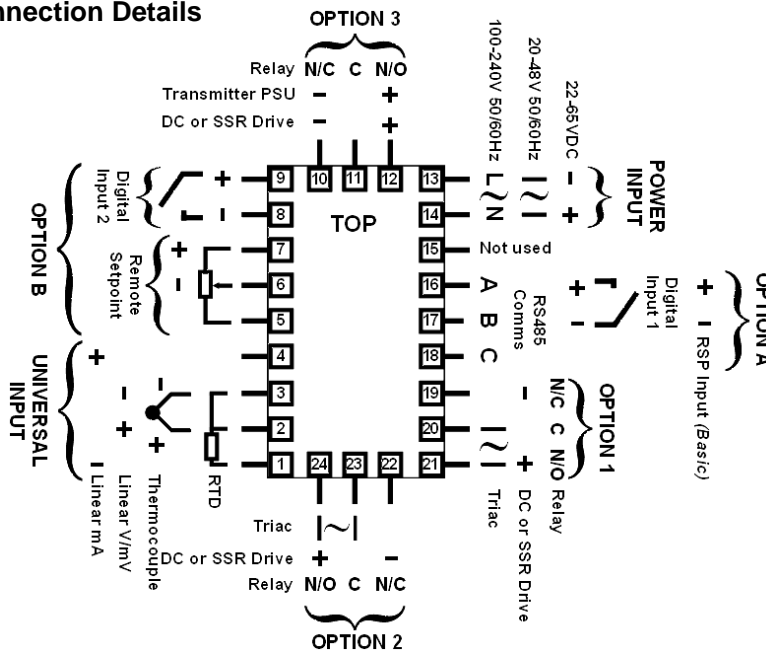

Field Reconfiguration

Input

Jumper-free configuration for any type
(no extra parts required)

- Option Slot 1** Part Number
 - Relay Output PO1-C10
 - Linear mA/V DC Output PO1-C21
 - SSR Driver Output PO1-C50
 - Triac Output PO1-C80
- Option Slot 2** Part Number
 - Relay Output PO2-C10
 - Linear mA/V DC Output PO2-C21
 - SSR Driver Output PO2-C50
 - Triac Output PO2-C80
- Option Slot 3** Part Number
 - Relay Output PO2-C10
 - Linear mA/V DC Output PO2-C21
 - SSR Driver Output PO2-C50
 - 24VDC Transmitter PSU PO2-W08
- Option Slot A** Part Number
 - Digital Input PA1-W03
 - Remote Setpoint Input (Basic) PA1-W04
 - RS485 Comms PA1-W06
- Option Slot B** Part Number
 - Remote Setpoint Input (Full) .. PB1-W0R

Order Code



Input Type

- 3 Wire RTD or DC mV 1
- Thermocouple 2
- DC mA 3
- DC Voltage 4

Option Slot 1

- Not fitted 0
- Relay 1
- DC for SSR 2
- DC 0-10V 3
- DC 0-20mA 4
- DC 0-5V 5
- DC 2-10V 6
- DC 4-20mA 7
- Triac 8

Option Slot 2

- Not fitted 0
- Relay 1
- DC Driver for SSR 2
- DC 0-10V 3
- DC 0-20mA 4
- DC 0-5V 5
- DC 2-10V 6
- DC 4-20mA 7
- Triac 8

Option Slot B

- 0 Not fitted
- R Remote Setpoint Input (Full)

Display Colour

- 0 Red Upper & Lower
- 1 Green Upper & Lower
- 2 Red Upper, Green Lower
- 3 Green Upper, Red Lower

Power Supply

- 0 100-240V AC
- 2 24-48V AC or DC

Option Slot A

- 0 Not fitted
- 1 RS485 Communications
- 3 Digital Input
- 4 Remote Setpoint Input (Basic)

Option Slot 3

- 0 Not fitted
- 1 Relay
- 2 DC Driver for SSR
- 3 DC 0-10V
- 4 DC 0-20mA
- 5 DC 0-5V
- 6 DC 2-10V
- 7 DC 4-20mA
- 8 Transmitter Power Supply